



Rechteckiger Tisch aus Massivholz, mit zwei Beinen je bestehend aus zwei integrierten Quadrern, wie ein Gegenstand und sein Schatten. Verbindung zwischen Massivholz, aus verleimten Leisten, und einem Teil aus Eisen. Bodenplatte aus Eisen..

STANDARD VERSION: METALLTEIL UND BODENPLATTE IRONDUST LACKIERT (B2)

ART.NR.	MASS	METALLTEILE	A1	A2	A4
OMBRA TABLE RETT1	L.240 x T.100 x H.75	B2	■	■	■
OMBRA TABLE RETT5	L.240 x T.110 x H.75	B2	■	■	■
OMBRA TABLE RETT2	L.260 x T.100 x H.75	B2	■	■	■
OMBRA TABLE RETT6	L.260 x T.110 x H.75	B2	■	■	■
OMBRA TABLE RETT3	L.280 x T.100 x H.75	B2	■	■	■
OMBRA TABLE RETT7	L.280 x T.110 x H.75	B2	■	■	■
OMBRA TABLE RETT4	L.300 x T.100 x H.75	B2	■	■	■
OMBRA TABLE RETT8	L.300 x T.110 x H.75	B2	■	■	■

VERFÜGBARE AUSFÜHRUNGEN:

- A1:** Nussbaum ohne Knoten, Nussbaum mit Knoten
- A2:** Eiche ohne Knoten, Eiche mit Knoten, Kirschbaum, Ahorn
- A4:** Eiche ohne Knoten pigmentiert: total black
Eiche mit Knoten pigmentiert: total black
- B2:** Eisen lackiert: irondust, RAL (nur ausgewählte Farben)

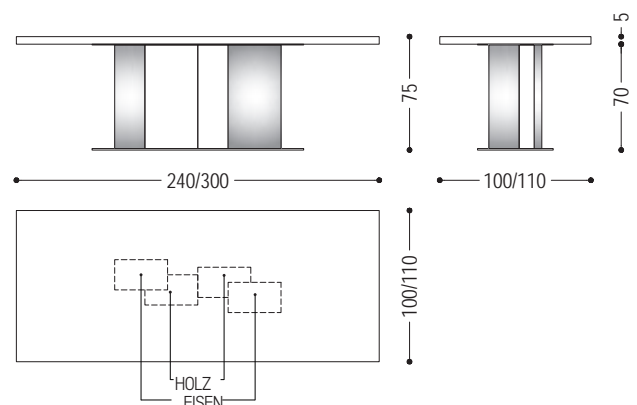

HOLZ

A1

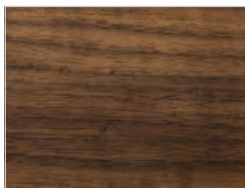

Nussbaum ohne Knoten



Nussbaum mit Knoten

A2

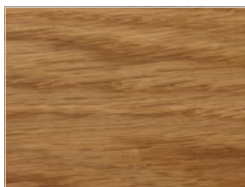

Eiche ohne Knoten

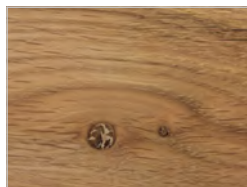

Eiche mit Knoten

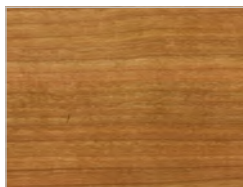

Kirschbaum



Ahorn

A4

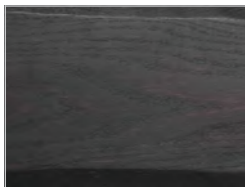









Eiche ohne Knoten pigmentiert:
total black

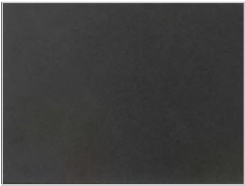
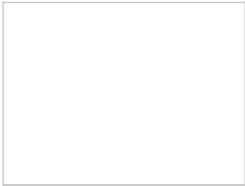

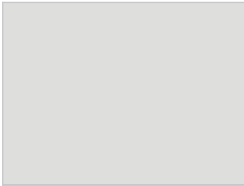
Eiche mit Knoten pigmentiert:
total black

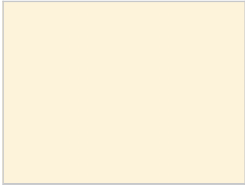
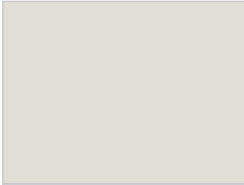
OMBRA TABLE RETTANGOLARE | VERFÜGBARE AUSFÜHRUNGEN

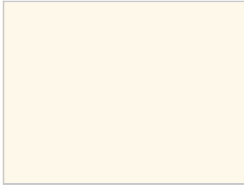
EISEN

B2					
	Eisen lackiert: iron dust	Eisen lackiert: RAL - 1013_PERLWEISS	Eisen lackiert: RAL - 3020_VERKEHRSROT	Eisen lackiert: RAL - 7035_LICHTGRAU	Eisen lackiert: RAL - 7037_STAUBGRAU
					
Eisen lackiert: RAL - 8019_GREY BROWN	Eisen lackiert: RAL - 9001_CREMEWEISS	Eisen lackiert: RAL - 9002_GRAUWEISS	Eisen lackiert: RAL - 9005_TIEFSCHWARZ	Eisen lackiert: RAL - 9010_REINWEISS	
					
Eisen lackiert: RAL - 9016_VERKEHRSWEISS					