



Tisch mit Platte bestehend aus verleimten Massivholzleisten, mit Naturkanten. Gestell aus Eisen.

**STANDARD VERSION: UNTERGESTELL AUS EISEN IRONDUST LACKIERT (B2)**

ART.NR.	MASS	GESTELL	A1	A2	A4
NATURA-TAV NEWTON9NS	L.160 x T.90 x H.75	B2	■	■	■
		B3	■	■	■
NATURA-TAV NEWTON10NS	L.180 x T.90 x H.75	B2	■	■	■
		B3	■	■	■
NATURA-TAV NEWTON11.1NS	L.200 x T.100 x H.75	B2	■	■	■
		B3	■	■	■
NATURA-TAV NEWTON12NS	L.220 x T.100 x H.75	B2	■	■	■
		B3	■	■	■
NATURA-TAV NEWTON13NS	L.240 x T.100 x H.75	B2	■	■	■
		B3	■	■	■
NATURA-TAV NEWTON14NS	L.260 x T.100 x H.75	B2	■	■	■
		B3	■	■	■
NATURA-TAV NEWTON15NS	L.280 x T.100 x H.75	B2	■	■	■
		B3	■	■	■
NATURA-TAV NEWTON16NS	L.300 x T.100 x H.75	B2	■	■	■
		B3	■	■	■

**VERFÜGBARE AUSFÜHRUNGEN:**

**A1:** Nussbaum mit Knoten

**A2:** Eiche mit Knoten

**A4:** Eiche mit Knoten pigmentiert: total black

**B2:** Eisen lackiert: irondust, RAL (nur ausgewählte Farben)

**B3:** Eisen lackiert, Effekt matt gebürstet: Bronze antik, Edelstahl, Titan

# NEWTON NATURAL SIDES

DETAIL: PLATTE MIT NATURKANTEN

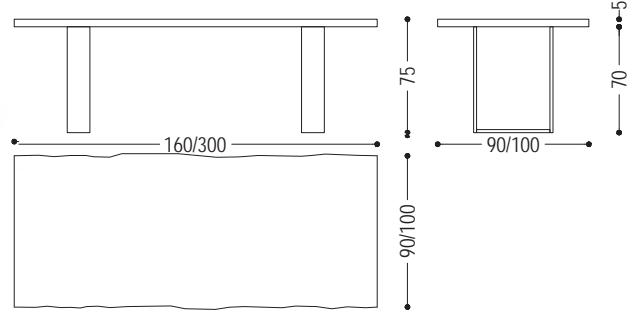

# NEWTON NATURAL SIDES | VERFÜGBARE AUSFÜHRUNGEN

## HOLZ

A1



Nussbaum mit Knoten

A2

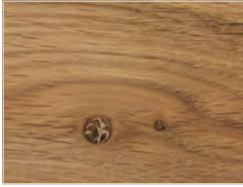

Eiche mit Knoten

A4



Eiche mit Knoten pigmentiert:  
total black

## EISEN

B2

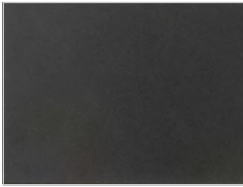

Eisen lackiert:  
ironrust



Eisen lackiert:  
RAL - 1013\_PERLWEISS



Eisen lackiert:  
RAL - 3020\_VERKEHRSROT

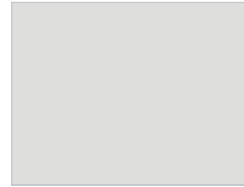

Eisen lackiert:  
RAL - 7035\_LICHTGRAU



Eisen lackiert:  
RAL - 7037\_STAUBGRAU



Eisen lackiert:  
RAL - 8019\_GREY BROWN

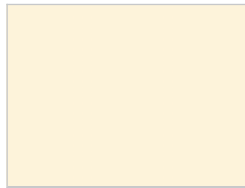

Eisen lackiert:  
RAL - 9001\_CREMEWEISS

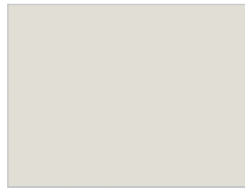

Eisen lackiert:  
RAL - 9002\_GRAUWEISS



Eisen lackiert:  
RAL - 9005\_TIEFSCHWARZ

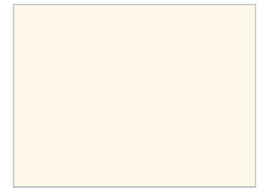

Eisen lackiert:  
RAL - 9010\_REINWEISS

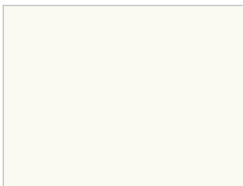

Eisen lackiert:  
RAL - 9016\_VERKEHRSWEISS

# NEWTON NATURAL SIDES | VERFÜGBARE AUSFÜHRUNGEN

---

B3

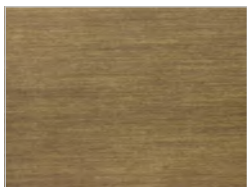

Eisen lackiert, Effekt matt gebürstet:  
Bronze antik

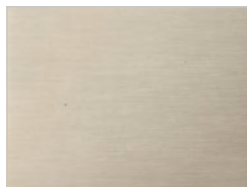

Eisen lackiert, Effekt matt gebürstet:  
Edelstahl

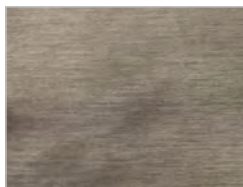

Eisen lackiert, Effekt matt gebürstet:  
Titan