



Couchtisch mit Platte aus Massivholz mit einer ausgefrästen Ablage und Gestell aus Eisen.

**STANDARD VERSION: GESTELL AUS EISEN, IRONDUST LACKIERT (B2)**

| ART.NR. | MASS                 | GESTELL | A1 | A2 | A4 |
|---------|----------------------|---------|----|----|----|
| IRONY 1 | L.80 x T.80 x H.38   | B2      | ■  | ■  | ■  |
|         |                      | B3      | ■  | ■  | ■  |
| IRONY 2 | L.100 x T.100 x H.38 | B2      | ■  | ■  | ■  |
|         |                      | B3      | ■  | ■  | ■  |
| IRONY 3 | L.120 x T.120 x H.38 | B2      | ■  | ■  | ■  |
|         |                      | B3      | ■  | ■  | ■  |
| IRONY 4 | L.140 x T.70 x H.38  | B2      | ■  | ■  | ■  |
|         |                      | B3      | ■  | ■  | ■  |
| IRONY 5 | L.120 x T.60 x H.38  | B2      | ■  | ■  | ■  |
|         |                      | B3      | ■  | ■  | ■  |

**VERFÜGBARE AUSFÜHRUNGEN:**

- A1:** Nussbaum ohne Knoten, Nussbaum mit Knoten
- A2:** Eiche ohne Knoten, Eiche mit Knoten, Kirschbaum, Ahorn
- A4:** Eiche ohne Knoten pigmentiert: total black  
Eiche mit Knoten pigmentiert: total black
- B2:** Eisen lackiert: irondust, RAL (nur ausgewählte Farben)
- B3:** Eisen lackiert, Effekt matt gebürstet: Bronze antik, Edelstahl, Titan

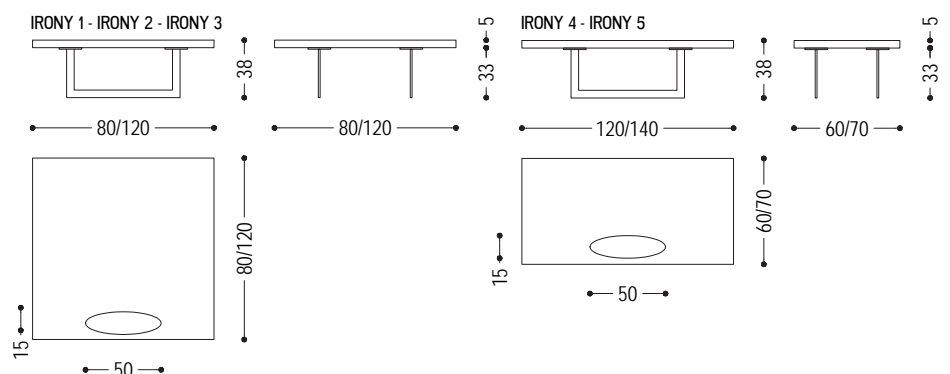

## HOLZ

A1



Nussbaum ohne Knoten



Nussbaum mit Knoten

A2

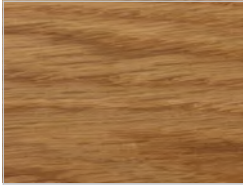

Eiche ohne Knoten



Eiche mit Knoten



Kirschbaum



Ahorn

A4

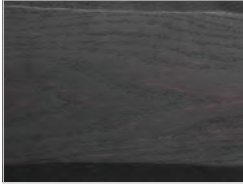









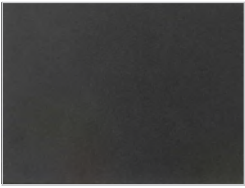

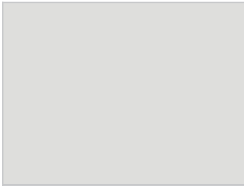

Eiche ohne Knoten pigmentiert:  
total black

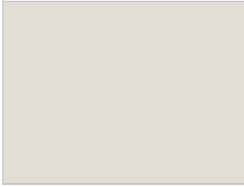

Eiche mit Knoten pigmentiert:  
total black

## EISEN

|    |  |  |  |   |   |
|----|--|--|--|---|---|
| B2 |   |   |   |  |  |
|    |   |   |   |  |  |
|    |   |  |  |   |   |
|    |  |  |  |   |   |