



Sedia imbottita con struttura realizzata in legno massello completamente tornita, assemblata e levigata a mano. Un intreccio di stringhe in pelle o tessuto caratterizza la seduta, che si distingue per il grande comfort. Nella versione in tessuto previsto rinforzo strutturale all'interno del rivestimento.

COD.	MISURE	PELLE TESSUTO	A1	A2
BUNGALOW CHAIR	L.64,5 x P.56 x H.45,5/80	D1	■	■
		D2	■	■
		D4	■	■

FINITURE DISPONIBILI:

A1: noce senza nodi

A2: rovere senza nodi

D1: tessuto: canvas, divina melange 2, hallingdal 65, velluto harald

D2: tessuto: maple

D4: pelle: utah

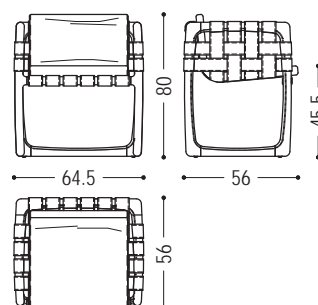

LEGNO

A1



noce senza nodi

A2

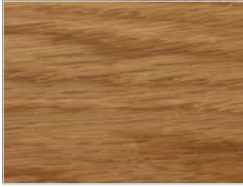

rovere senza nodi

PELLE / TESSUTO



tessuto canvas:
114

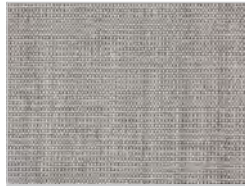

tessuto canvas:
124

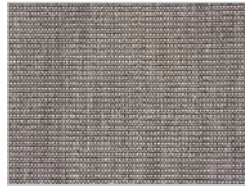

tessuto canvas:
134

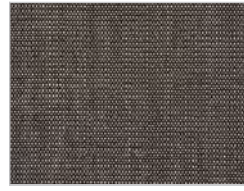

tessuto canvas:
154



tessuto canvas:
174



tessuto divina melange 2:
120



tessuto divina melange 2:
170



tessuto divina melange 2:
180



tessuto divina melange 2:
220

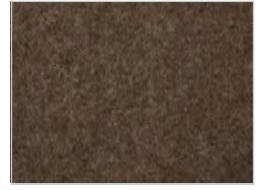

tessuto divina melange 2:
260

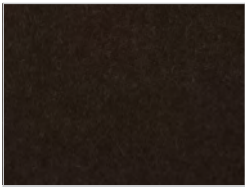

tessuto divina melange 2:
280



tessuto hallingdal 65:
103



tessuto hallingdal 65:
116



tessuto hallingdal 65:
130

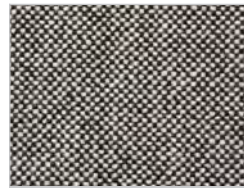

tessuto hallingdal 65:
166



tessuto hallingdal 65:
180



tessuto velluto harald:
182



tessuto velluto harald:
242



tessuto velluto harald:
283



tessuto velluto harald:
443



tessuto velluto harald:
512



tessuto velluto harald:
552

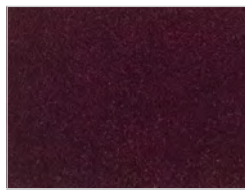

tessuto velluto harald:
582



tessuto velluto harald:
792



tessuto velluto harald:
982

D1

BUNGALOW DINING CHAIR | FINITURE DISPONIBILI

D2

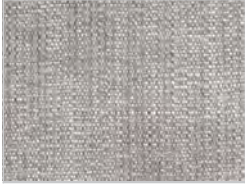

tessuto maple:
112



tessuto maple:
132



tessuto maple:
142



tessuto maple:
162



tessuto maple:
192



tessuto maple:
222



tessuto maple:
232



tessuto maple:
362

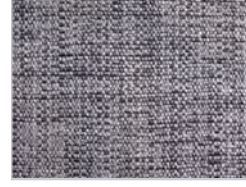

tessuto maple:
742



tessuto maple:
792

D4



pelle utah:
101



pelle utah:
102



pelle utah:
103



pelle utah:
104



pelle utah:
105



pelle utah:
106

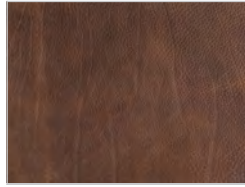

pelle utah:
107



pelle utah:
108