



Sessel mit Struktur aus Massivholz, mit Rückenlehne und bequemem gepolstertem Sitz mit Bezug aus Leder oder Stoff und sichtbaren Nähten.

WICHTIG: UM DEN PREIS ZU RECHNEN, BITTE, HOLZSTRUKTUR, RÜCKENLEHNE UND SITZKISSEN SUMMIEREN

RÜCKENLEHNE IN STOFF MAPLE NICHT ERHÄLTICH

ART.NR.	MASS	FÜR STRUKTUR		
		A1	A2	A4
NOBLÉ ARMCHAIR	L.73 x T.76 x H.44/75	■	■	■

VERFÜGBARE AUSFÜHRUNGEN:

- A1:** Nussbaum ohne Knoten
- A2:** Eiche ohne Knoten, Kirschbaum, Ahorn
- A4:** Eiche ohne Knoten pigmentiert: total black

FÜR RÜCKENLEHNE	
D1	■
D3	■
D4	■
D6	■

VERFÜGBARE AUSFÜHRUNGEN:

- D1:** Stoff: canvas, divina melange 2, hallingdal 65, Samt harald
- D3:** Leder: camoscio, cristal
- D4:** Leder: nabuk, utah
- D6:** Kundenleder, Kundenstoff

FÜR SITZKISSEN	
D1	■
D2	■
D3	■
D4	■
D6	■

VERFÜGBARE AUSFÜHRUNGEN:

- D1:** Stoff: canvas, divina melange 2, hallingdal 65, Samt harald
- D2:** Stoff: maple
- D3:** Leder: camoscio, cristal
- D4:** Leder: nabuk, utah
- D6:** Kundenleder, Kundenstoff

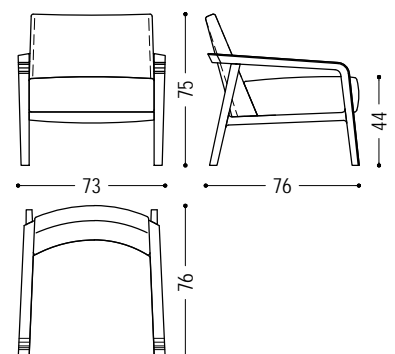

HOLZ

A1

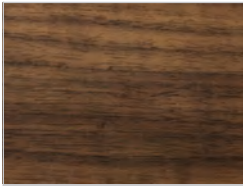

Nussbaum ohne Knoten

A2

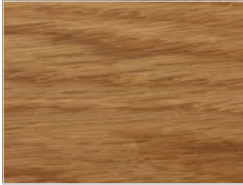

Eiche ohne Knoten



Kirschbaum



Ahorn



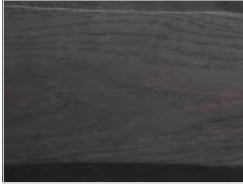







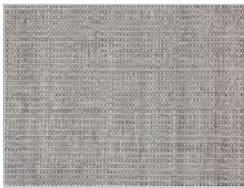
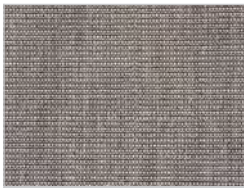
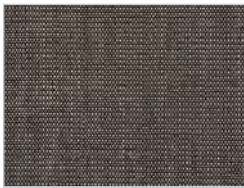





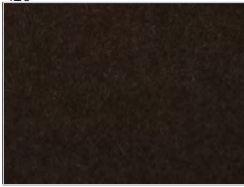



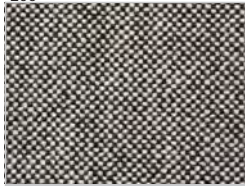









A4

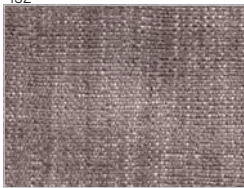

Eiche ohne Knoten pigmentiert:
total black

NOBLÉ ARMCHAIR | VERFÜGBARE AUSFÜHRUNGEN

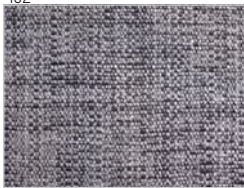
LEDER/STOFFE

D1					
	Stoff: canvas: 114	Stoff: canvas: 124	Stoff: canvas: 134	Stoff: canvas: 154	Stoff: canvas: 174
					
	Stoff: divina melange 2: 120	Stoff: divina melange 2: 170	Stoff: divina melange 2: 180	Stoff: divina melange 2: 220	Stoff: divina melange 2: 260
					
	Stoff: divina melange 2: 280	Stoff: hallingdal 65: 103	Stoff: hallingdal 65: 116	Stoff: hallingdal 65: 130	Stoff: hallingdal 65: 166
					
	Stoff: hallingdal 65: 180	Stoff: Samt harald: 182	Stoff: Samt harald: 242	Stoff: Samt harald: - 283	Stoff: hallingdal 65: 443
					
	Stoff: Samt harald: 512	Stoff: Samt harald: 552	Stoff: Samt harald: 582	Stoff: Samt harald: 792	Stoff: Samt harald: 982
D2					
	Stoff: maple: 112	Stoff: maple: 132	Stoff: maple: 142	Stoff: maple: 162	Stoff: maple: 192
					
	Stoff: maple: 222	Stoff: maple: 232	Stoff: maple: 362	Stoff: maple: 742	Stoff: maple: 792

NOBLÉ ARMCHAIR | VERFÜGBARE AUSFÜHRUNGEN

D3



Leder camoscio:
1



Leder camoscio:
10

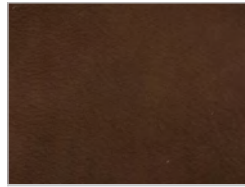

Leder camoscio:
11



Leder camoscio:
26



Leder camoscio:
27

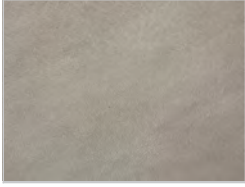

Leder camoscio:
28



Leder camoscio:
31

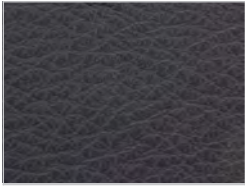

Leder cristal:
13



Leder cristal:
14



Leder cristal:
17

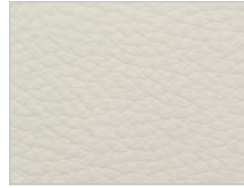

Leder cristal:
18



Leder cristal:
37



Leder cristal:
49



Leder cristal:
51



Leder cristal:
65

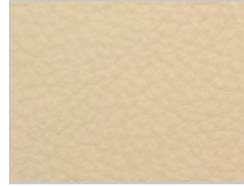

Leder cristal:
70

NOBLÉ ARMCHAIR | VERFÜGBARE AUSFÜHRUNGEN

D4					
	Leder nabuk: 6	Leder nabuk: 12	Leder nabuk: 15	Leder nabuk: 18	Leder nabuk: 23
					
	Leder nabuk: 27	Leder nabuk: 28	Leder nabuk: 30	Leder nabuk: 36	Leder nabuk: 42
					
	Leder utah: 101	Leder utah: 102	Leder utah: 103	Leder utah: 104	Leder utah: 105
					
	Leder utah: 106	Leder utah: 107	Leder utah: 108		