



Vetrina alta con struttura in legno massello caratterizzata da ante e spalle in vetro, utilizzato anche per i ripiani interni. Ripiano centrale fisso in legno. Disponibile in versione a 2 o 4 ante in vetro, con cassetteria interna o esterna, e base in ferro. Innovativo sistema di luci LED con accensione autonoma e ricarica wireless.

ATTREZZATURA STANDARD: VEDERE DISEGNI TECNICI

ACCESSORI AGGIUNTIVI: CONSULTARE PAGINE INTRODUTTIVE

ATTENZIONE: SPEDITA MONTATA, NON SMONTABILE

VERSIONE STANDARD: ANTE, SPALLE E RIPIANI IN VETRO TRASPARENTE (E1); BASE IN FERRO LACCATO COLORE IRONDUST (B2); MANIGLIE FR80

COD.	MISURE	BASE E FERRAMENTA	VETRI	A1	A2	A4
ADA 2.1	L.123 x P.48 x H.204,4	B2	E1	■	■	■
			E2	■	■	■
		B3	E1	■	■	■
			E2	■	■	■
ADA 2.2	L.123 x P.48 x H.204,4	B2	E1	■	■	■
			E2	■	■	■
		B3	E1	■	■	■
			E2	■	■	■
ADA 2.3	L.123 x P.48 x H.204,4	B2	E1	■	■	■
			E2	■	■	■
		B3	E1	■	■	■
			E2	■	■	■

FINITURE DISPONIBILI:

A1: noce senza nodi

A2: rovere senza nodi, ciliegio, acero

A4: rovere senza nodi pigmentato: total black

E1: vetro: trasparente / extra chiaro, satinato

E2: vetro: fumé, bronzato

B2: ferro laccato: iron dust, RAL (solo colori selezionati)

B3: ferro laccato effetto spazzolato opaco: bronzo antico, acciaio, titanio

N.B.: A RICHIESTA INTERNO DEI CASSETTI IN LEGNO DI CEDRO PROFUMATO, STESSO PREZZO

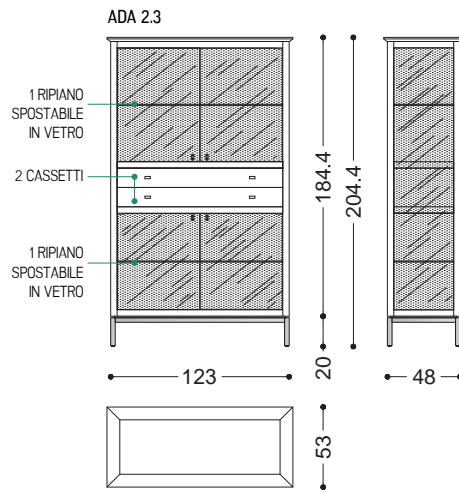
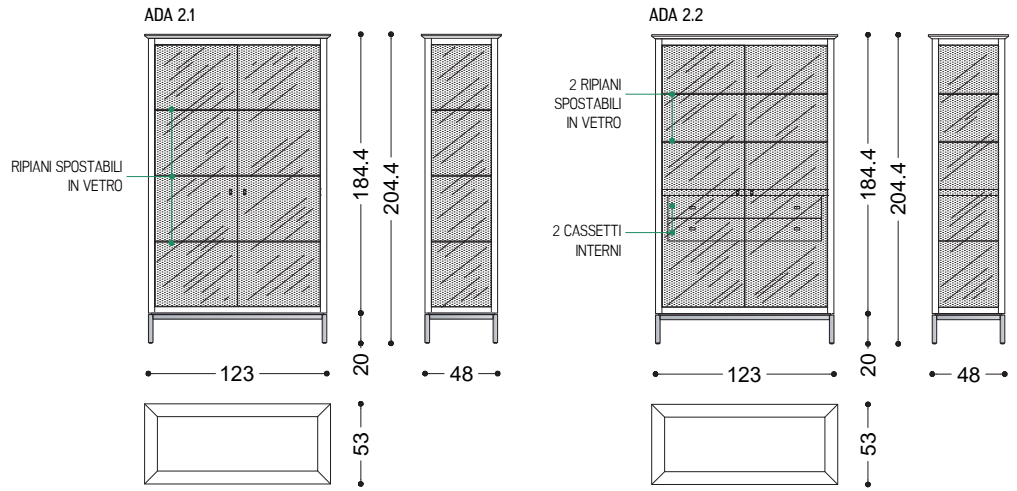

LEGNO

A1

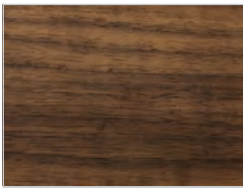

noce senza nodi

A2

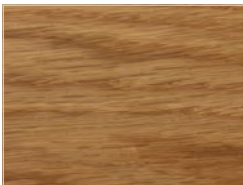

rovere senza nodi

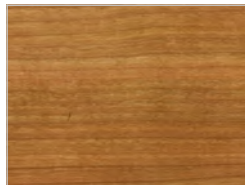

cilegio

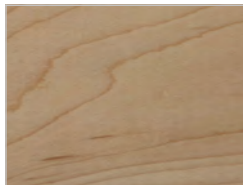

acero

A4

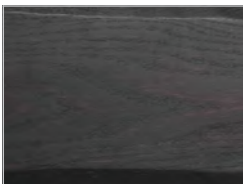

rovere senza nodi pigmentato:
total black

FERRO

B2

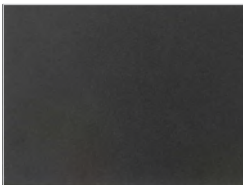

ferro laccato:
iron dust

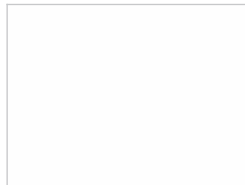

ferro laccato:
RAL - 1013_BIANCO PERLA



ferro laccato:
RAL - 3020_ROSSO TRAFFICO

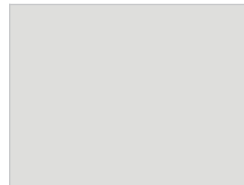

ferro laccato:
RAL - 7035_GRIGIO LUCE



ferro laccato:
RAL - 7037_GRIGIO POLVERE



ferro laccato:
RAL - 8019_MARRONE GRIGIASTRO

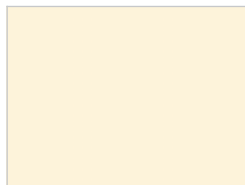

ferro laccato:
RAL - 9001_BIANCO CREMA

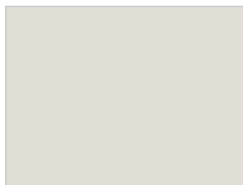

ferro laccato:
RAL - 9002_BIANCO GRIGIASTRO

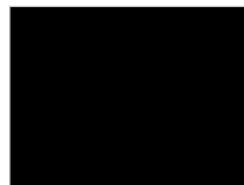

ferro laccato:
RAL - 9005_NERO INTENSO

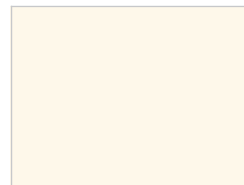

ferro laccato:
RAL - 9010_BIANCO PURO

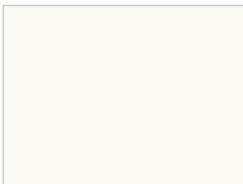

ferro laccato:
RAL - 9016_BIANCO TRAFFICO

ADA 2.0 | FINITURE DISPONIBILI

B3

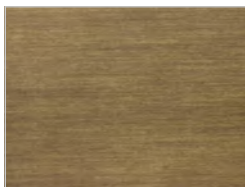

ferro laccato effetto spazzolato opaco:
bronzo antico

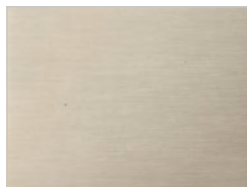

ferro laccato effetto spazzolato opaco:
acciaio

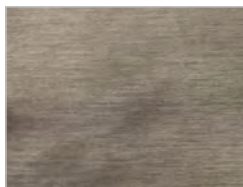

ferro laccato effetto spazzolato opaco:
titanio

PELLE / TESSUTO

D3

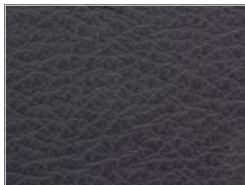

pelle cristal:
13

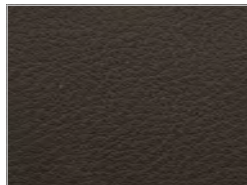

pelle cristal:
14

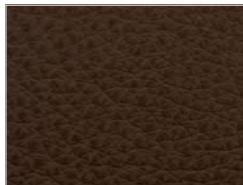

pelle cristal:
17

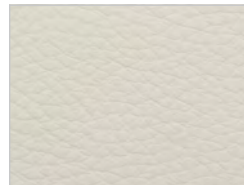

pelle cristal:
18

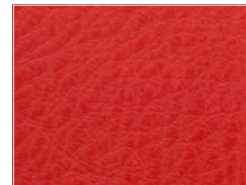

pelle cristal:
37

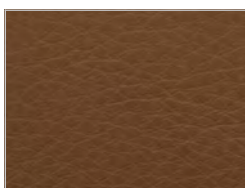

pelle cristal:
49

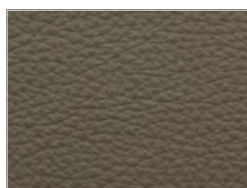

pelle cristal:
51

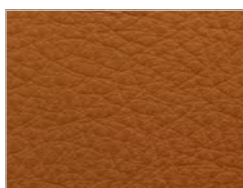

pelle cristal:
65

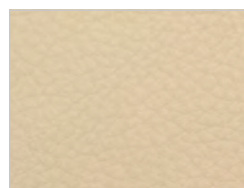

pelle cristal:
70

VETRO

E1



vetro trasparente / extra chiaro



vetro satinato

E2



vetro FUMÉ



vetro BRONZATO