



Sofa mit Bezug aus Leder oder Stoff mit sichtbaren Nähten. Mit Gestell aus Eisen, erhältlich in verschiedenen Kombinationen, davon einige mit Massivholzablage in Nussbaum aus einem einzigen massiven Block gewonnen. Einige andere Kombinationen können als Zeitschriften Couchtisch oder Handschufach benutzt werden.

**STANDARD VERSION:** GESTELL AUS EISEN IRONDUST LACKIERT (B2)- HOLZABLAGE AUS NUSSBAUM MIT KNOTEN

IM FOTO: MODELL 1.245 IN LEDER CRISTAL (D3)

STANDARD VERSION: MODELL 1.245 LEATHER: HINTEN GLATT VERARBEITET

PATMOS SOFA							
ART.NR.	MASS	GESTELL	D1	D2	D3	D4	D6
PATMOS1.1.210	L.210 x T.98 x H.42/92	B2	■	■	■	■	■
		B3	■	■	■	■	■
PATMOS 1.245	L.245 x T.98 x H.42/92	B2	■	■	■	■	■
		B3	■	■	■	■	■

**VERFÜGBARE AUSFÜHRUNGEN:**

**D1:** Stoff: canvas, divina melange 2, hallingdal 65, Samt harald

**D2:** Stoff: maple

**D3:** Leder: camoscio, cristal

**D4:** Leder: nabuk, utah

**D6:** Kundenleder, Kundenstoff

**B2:** Eisen lackiert: irondust, RAL (nur ausgewählte Farben)

**B3:** Eisen lackiert, Effekt matt gebürstet: Bronze antik, Edelstahl, Titan

PATMOS 1.1.210

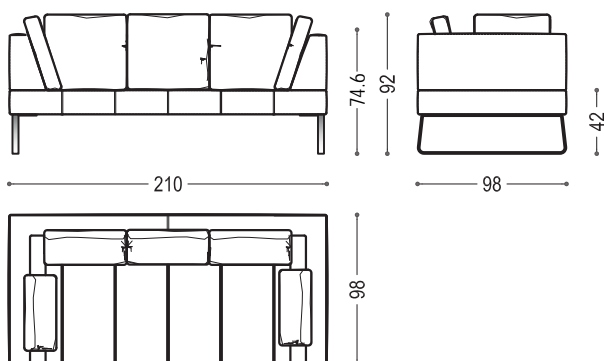

PATMOS 1.245

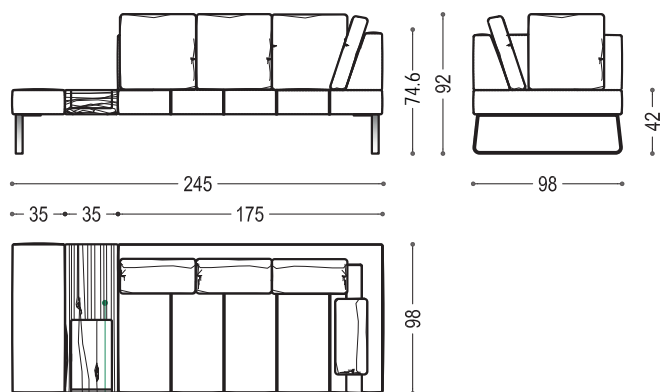

ABLAGE AUS NUSSBAUM MASSIV MIT KNOTEN

# PATMOS

## PATMOS BENCH

ART.NR.	MASS	GESTELL	D1	D2	D3	D4	D6
PATMOS 1.245 LEATHER	L.245 x T.98 x H.42/74,6	B2	■	■	■	■	■
		B3	■	■	■	■	■

### VERFÜGBARE AUSFÜHRUNGEN:

**D1:** Stoff: canvas, divina melange 2, hallingdal 65, Samt harald

**D2:** Stoff: maple

**D3:** Leder: camoscio, cristal

**D4:** Leder: nabuk, utah

**D6:** Kundenleder, Kundenstoff

**B2:** Eisen lackiert: irondust, RAL (nur ausgewählte Farben)

**B3:** Eisen lackiert, Effekt matt gebürstet: Bronze antik, Edelstahl, Titan

### AU' FÜR LEDER / STOFF VARIANTEN

RAUTENNÄHTE AUF DER RÜCKENLEHNE	■
---------------------------------	---

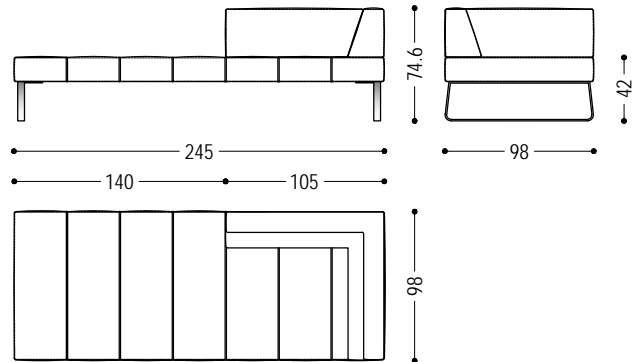

## PATMOS POUF

ART.NR.	MASS	GESTELL	D1	D2	D3	D4	D6
PATMOS 3.1.140	L.140 x T.65 x H.42	B2	■	■	■	■	■
		B3	■	■	■	■	■
PATMOS 3.1.175	L.175 x T.65 x H.42	B2	■	■	■	■	■
		B3	■	■	■	■	■

### VERFÜGBARE AUSFÜHRUNGEN:

**D1:** Stoff: canvas, divina melange 2, hallingdal 65, Samt harald

**D2:** Stoff: maple

**D3:** Leder: camoscio, cristal

**D4:** Leder: nabuk, utah

**D6:** Kundenleder, Kundenstoff

**B2:** Eisen lackiert: irondust, RAL (nur ausgewählte Farben)

**B3:** Eisen lackiert, Effekt matt gebürstet: Bronze antik, Edelstahl, Titan

PATMOS 3.1.140

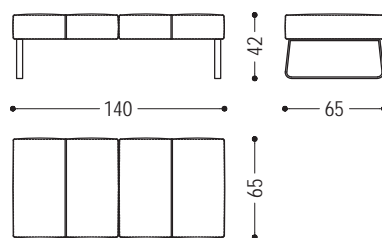



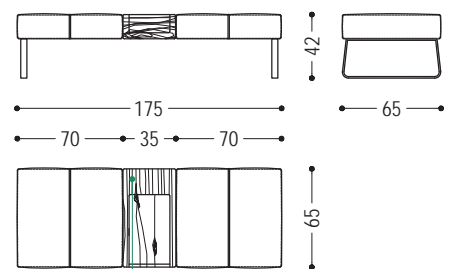





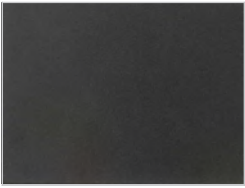

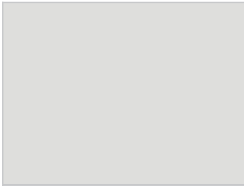

PATMOS 3.1.175

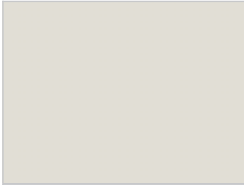









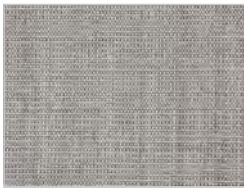
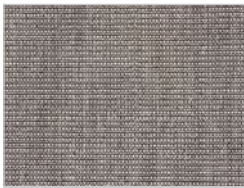
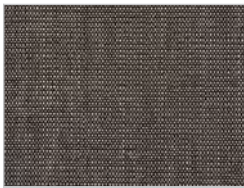





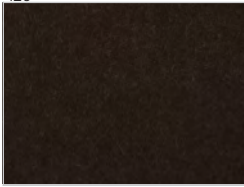



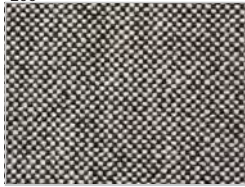











ABLAGE AUS NUSSBAUM MASSIV MIT KNOTEN

## EISEN

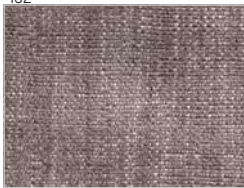
B2					
	<p>Eisen lackiert: iron dust</p>	<p>Eisen lackiert: RAL - 1013_PERLWEISS</p>	<p>Eisen lackiert: RAL - 3020_VERKEHRSROT</p>	<p>Eisen lackiert: RAL - 7035_LICHTGRAU</p>	<p>Eisen lackiert: RAL - 7037_STAUBGRAU</p>
					
	<p>Eisen lackiert: RAL - 8019_GREY BROWN</p>	<p>Eisen lackiert: RAL - 9001_CREMEWEISS</p>	<p>Eisen lackiert: RAL - 9002_GRAUWEISS</p>	<p>Eisen lackiert: RAL - 9005_TIEFSCHWARZ</p>	<p>Eisen lackiert: RAL - 9010_REINWEISS</p>
					
	<p>Eisen lackiert: RAL - 9016_VERKEHRSWEISS</p>				
B3					
	<p>Eisen lackiert, Effekt matt gebürstet: Bronze antik</p>	<p>Eisen lackiert, Effekt matt gebürstet: Edelstahl</p>	<p>Eisen lackiert, Effekt matt gebürstet: Titan</p>		

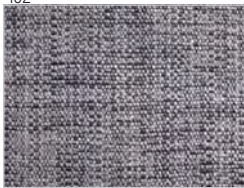
## LEDER/STOFFE

D1					
	Stoff: canvas: 114	Stoff: canvas: 124	Stoff: canvas: 134	Stoff: canvas: 154	Stoff: canvas: 174
					
	Stoff: divina melange 2: 120	Stoff: divina melange 2: 170	Stoff: divina melange 2: 180	Stoff: divina melange 2: 220	Stoff: divina melange 2: 260
					
	Stoff: divina melange 2: 280	Stoff: hallingdal 65: 103	Stoff: hallingdal 65: 116	Stoff: hallingdal 65: 130	Stoff: hallingdal 65: 166
					
	Stoff: hallingdal 65: 180	Stoff: Samt harald: 182	Stoff: Samt harald: 242	Stoff: Samt harald: - 283	Stoff: hallingdal 65: 443
					
	Stoff: Samt harald: 512	Stoff: Samt harald: 552	Stoff: Samt harald: 582	Stoff: Samt harald: 792	Stoff: Samt harald: 982
D2					
	Stoff: maple: 112	Stoff: maple: 132	Stoff: maple: 142	Stoff: maple: 162	Stoff: maple: 192
					
	Stoff: maple: 222	Stoff: maple: 232	Stoff: maple: 362	Stoff: maple: 742	Stoff: maple: 792



# PATMOS | VERFÜGBARE AUSFÜHRUNGEN

D3



Leder camoscio:  
1



Leder camoscio:  
10

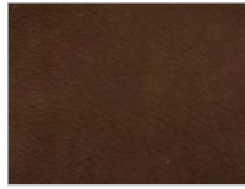

Leder camoscio:  
11



Leder camoscio:  
26



Leder camoscio:  
27

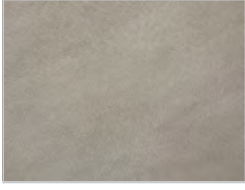

Leder camoscio:  
28



Leder camoscio:  
31

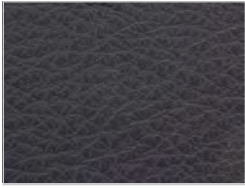

Leder cristal:  
13



Leder cristal:  
14



Leder cristal:  
17

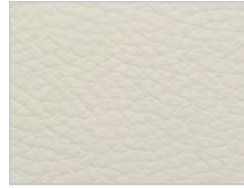

Leder cristal:  
18



Leder cristal:  
37



Leder cristal:  
49



Leder cristal:  
51



Leder cristal:  
65

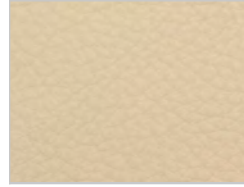

Leder cristal:  
70

# PATMOS | VERFÜGBARE AUSFÜHRUNGEN

D4					
	Leder nabuk: 6	Leder nabuk: 12	Leder nabuk: 15	Leder nabuk: 18	Leder nabuk: 23
					
	Leder nabuk: 27	Leder nabuk: 28	Leder nabuk: 30	Leder nabuk: 36	Leder nabuk: 42
					
	Leder utah: 101	Leder utah: 102	Leder utah: 103	Leder utah: 104	Leder utah: 105
					
	Leder utah: 106	Leder utah: 107	Leder utah: 108		