



Sofa mit linearem Gestell aus Massivholz; Kissen, Armlehne und Rückenlehne aus Leder oder Stoff bezogen. In verschiedenen Maßen erhältlich.

IM FOTO: NUSSBAUM (A1) + STRUKTUR IN LEDER NABUK (D4) + SITZ-UND RÜCKENKISSEN IN STOFF MAPLE (D2)

ART.NR.	MASS	FÜR HOLZSTRUKTUR		
		A1	A2	A4
MAOLI 100	L100 x T.96 x H.42/81,5	■	■	■
MAOLI 200/220	L.200/220 x T.96 x H.42/81,5	■	■	■
MAOLI 280/300	L.280/300 x T.96 x H.42/81,5	■	■	■

VERFÜGBARE AUSFÜHRUNGEN:

- A1:** Nussbaum ohne Knoten, Nussbaum mit Knoten
- A2:** Eiche ohne Knoten, Eiche mit Knoten, Kirschbaum, Ahorn
- A4:** Eiche ohne Knoten pigmentiert: total black
Eiche mit Knoten pigmentiert: total black

FÜR STRUKTURBEZUG	MAOLI 100	MAOLI 200/220	MAOLI 280/300
D1	■	■	■
D2	■	■	■
D3	■	■	■
D4	■	■	■
D6	■	■	■

VERFÜGBARE AUSFÜHRUNGEN:

- D1:** Stoff: canvas, divina melange 2, hallingdal 65, Samt harald
- D2:** Stoff: maple
- D3:** Leder: camoscio, cristal
- D4:** Leder: nabuk, utah
- D6:** Kundenleder, Kundenstoff

MAOLI

FÜR KISSENBEZUG	MAOLI 100	MAOLI 200/220	MAOLI 280/300
D1	■	■	■
D2	■	■	■
D3	■	■	■
D4	■	■	■
D6	■	■	■

VERFÜGBARE AUSFÜHRUNGEN:

D1: Stoff: canvas, divina melange 2, hallingdal 65, Samt harald

D2: Stoff: maple

D3: Leder: camoscio, cristal

D4: Leder: nabuk, utah

D6: Kundenleder, Kundenstoff

MAOLI 100

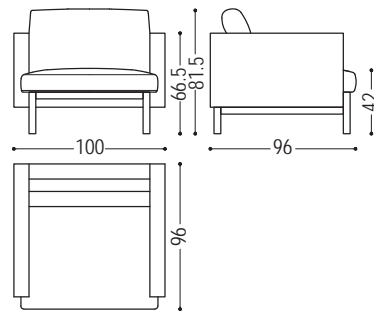

MAOLI 200/220

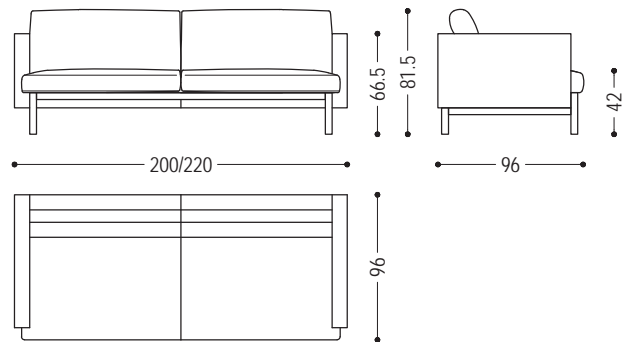

MAOLI 280/300

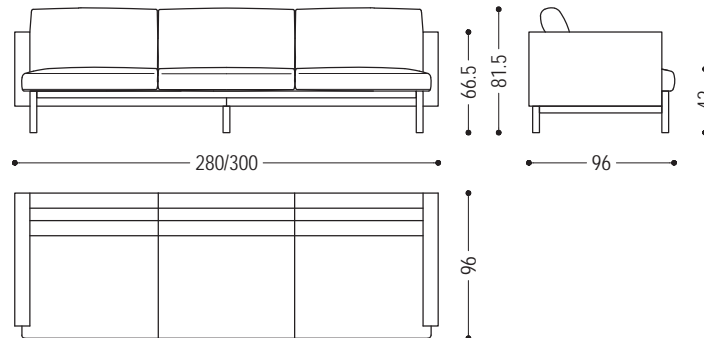

HOLZ

A1

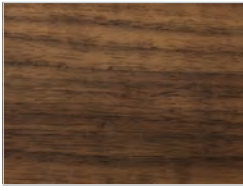

Nussbaum ohne Knoten



Nussbaum mit Knoten

A2

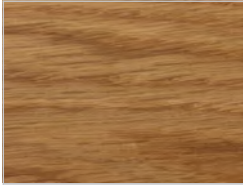

Eiche ohne Knoten



Eiche mit Knoten



Kirschbaum



Ahorn

A4

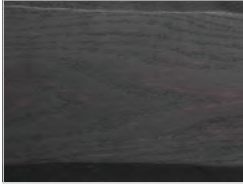









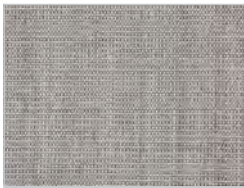
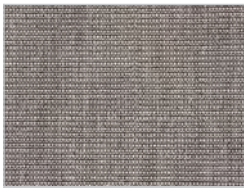
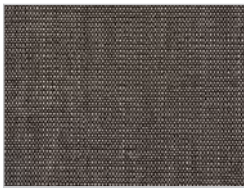





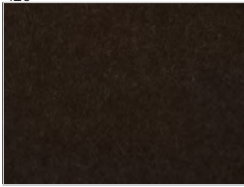



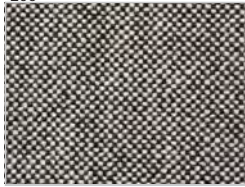











Eiche ohne Knoten pigmentiert:
total black

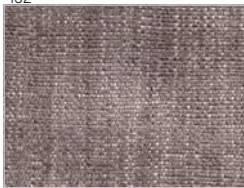

Eiche mit Knoten pigmentiert:
total black

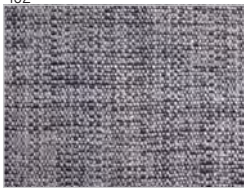
LEDER/STOFFE

D1					
	Stoff: canvas: 114	Stoff: canvas: 124	Stoff: canvas: 134	Stoff: canvas: 154	Stoff: canvas: 174
					
	Stoff: divina melange 2: 120	Stoff: divina melange 2: 170	Stoff: divina melange 2: 180	Stoff: divina melange 2: 220	Stoff: divina melange 2: 260
					
	Stoff: divina melange 2: 280	Stoff: hallingdal 65: 103	Stoff: hallingdal 65: 116	Stoff: hallingdal 65: 130	Stoff: hallingdal 65: 166
					
	Stoff: hallingdal 65: 180	Stoff: Samt harald: 182	Stoff: Samt harald: 242	Stoff: Samt harald: - 283	Stoff: hallingdal 65: 443
					
	Stoff: Samt harald: 512	Stoff: Samt harald: 552	Stoff: Samt harald: 582	Stoff: Samt harald: 792	Stoff: Samt harald: 982
D2					
	Stoff: maple: 112	Stoff: maple: 132	Stoff: maple: 142	Stoff: maple: 162	Stoff: maple: 192
					
	Stoff: maple: 222	Stoff: maple: 232	Stoff: maple: 362	Stoff: maple: 742	Stoff: maple: 792

MAOLI | VERFÜGBARE AUSFÜHRUNGEN

D3



Leder camoscio:
1



Leder camoscio:
10

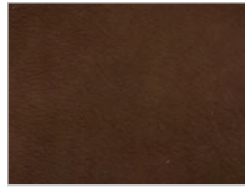

Leder camoscio:
11



Leder camoscio:
26



Leder camoscio:
27

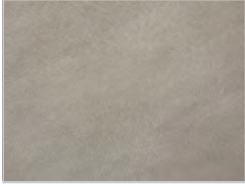

Leder camoscio:
28



Leder camoscio:
31

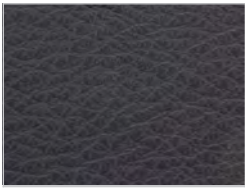

Leder cristal:
13



Leder cristal:
14



Leder cristal:
17



Leder cristal:
18



Leder cristal:
37



Leder cristal:
49



Leder cristal:
51



Leder cristal:
65

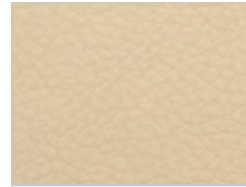

Leder cristal:
70

MAOLI | VERFÜGBARE AUSFÜHRUNGEN

D4					
	Leder nabuk: 6	Leder nabuk: 12	Leder nabuk: 15	Leder nabuk: 18	Leder nabuk: 23
					
	Leder nabuk: 27	Leder nabuk: 28	Leder nabuk: 30	Leder nabuk: 36	Leder nabuk: 42
					
	Leder utah: 101	Leder utah: 102	Leder utah: 103	Leder utah: 104	Leder utah: 105
					
	Leder utah: 106	Leder utah: 107	Leder utah: 108		