



Flexibles und dynamisches Sitzprogramm, das zu jedes Raum passt. Sockel aus Massivholz kombiniert mit weichen Kissen, mit Leder- oder Stoffbezug und sichtbaren Nähten. Dieses Modell besteht aus mehreren Elementen, die zusammen kombiniert werden können.

IM FOTO: NUSSBAUM (A1) + STOFF HALLINGDAL 65 (D1)
 ANGEGEBENE PREISE: WIE IM FOTO. DEKOKISSEN NICHT INBEGRIFFEN

PREIS DES GESTELLS GILT FÜR DIE KATEGORIEN A1 - A2 - A4

KOMBINATION		
ART.NR.	MASS	D1
HERITAGE_COMPOSITION	L.400/280 x T.100 x H.42/82	■

VERFÜGBARE AUSFÜHRUNGEN:

D1: Stoff: canvas, divina melange 2, hallingdal 65, Samt harald

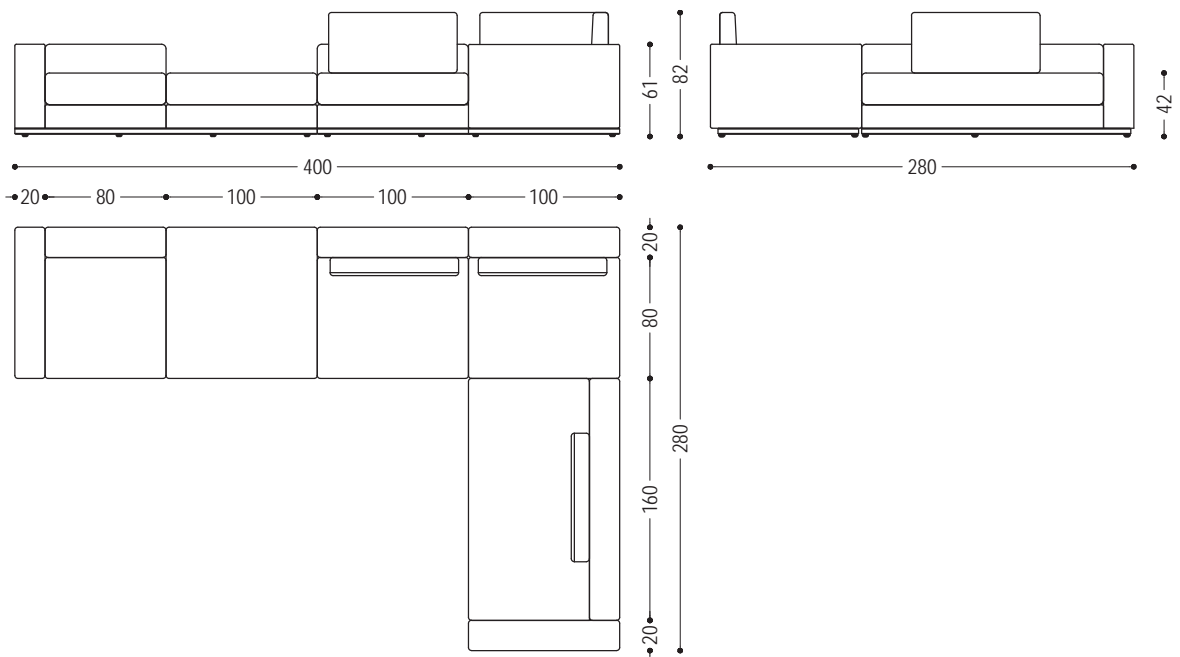

HERITAGE

HERITAGE MOD 100

ART.NR.	MASS	D1	D2	D3	D4	D6
HR 100	L.100 x T.100 x H.42/61	■	■	■	■	■

VERFÜGBARE AUSFÜHRUNGEN:

D1: Stoff: canvas, divina melange 2, hallingdal 65, Samt harald

D2: Stoff: maple

D3: Leder: camoscio, cristal

D4: Leder: nabuk, utah

D6: Kundenleder, Kundenstoff

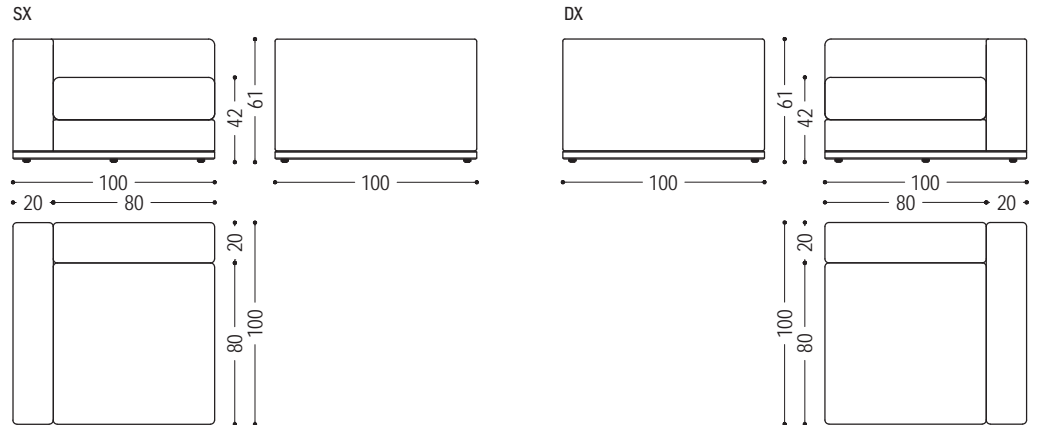

HERITAGE MOD 180

ART.NR.	MASS	D1	D2	D3	D4	D6
HR 180	L.180 x T.100 x H.42	■	■	■	■	■

VERFÜGBARE AUSFÜHRUNGEN:

D1: Stoff: canvas, divina melange 2, hallingdal 65, Samt harald

D2: Stoff: maple

D3: Leder: camoscio, cristal

D4: Leder: nabuk, utah

D6: Kundenleder, Kundenstoff

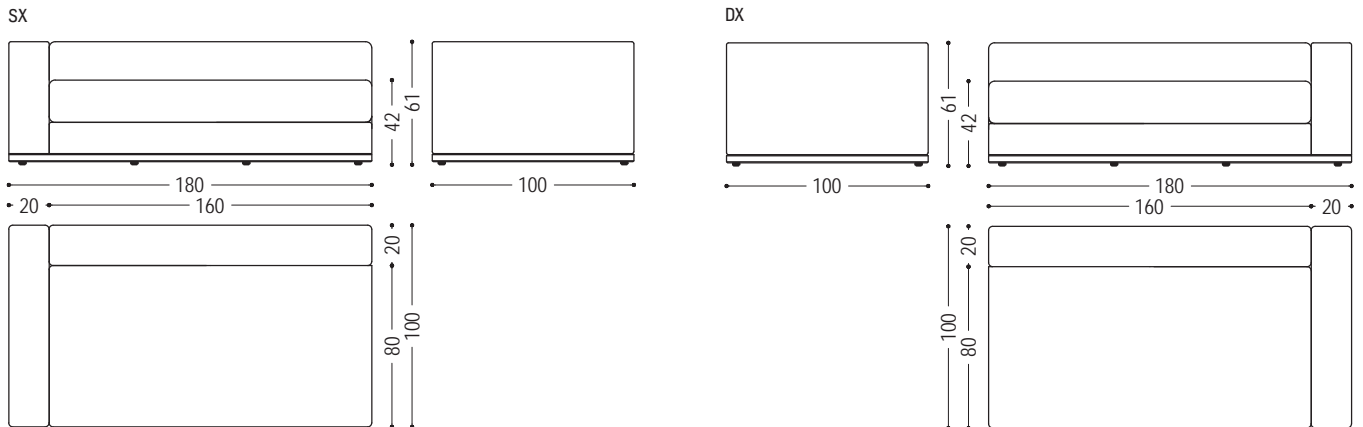

HERITAGE

HERITAGE MOD 80 MC

ART.NR.	MASS	D1	D2	D3	D4	D6
HR 80 MC	L.80 x T.100 x H.42/61	■	■	■	■	■

VERFÜGBARE AUSFÜHRUNGEN:

D1: Stoff: canvas, divina melange 2, hallingdal 65, Samt harald

D2: Stoff: maple

D3: Leder: camoscio, cristal

D4: Leder: nabuk, utah

D6: Kundenleder, Kundenstoff

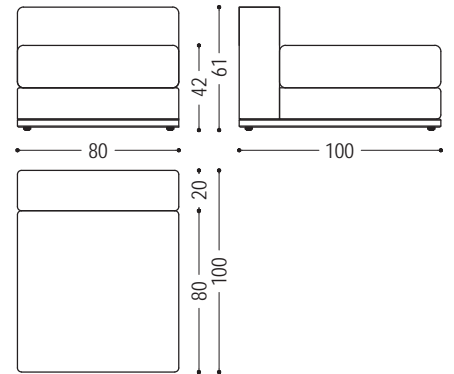

HERITAGE MOD 100 MC

ART.NR.	MASS	D1	D2	D3	D4	D6
HR 100 MC	L.100 x T.100 x H.42/61	■	■	■	■	■

VERFÜGBARE AUSFÜHRUNGEN:

D1: Stoff: canvas, divina melange 2, hallingdal 65, Samt harald

D2: Stoff: maple

D3: Leder: camoscio, cristal

D4: Leder: nabuk, utah

D6: Kundenleder, Kundenstoff

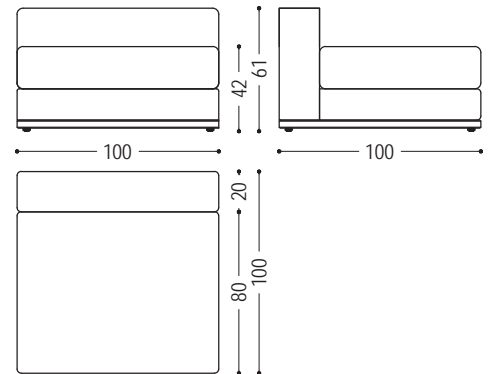

HERITAGE

HERITAGE MOD 100-180

ART.NR.	MASS	D1	D2	D3	D4	D6
HR 100-180	L.100 x T.100 x H.42/61	■	■	■	■	■

VERFÜGBARE AUSFÜHRUNGEN:

D1: Stoff: canvas, divina melange 2, hallingdal 65, Samt harald

D2: Stoff: maple

D3: Leder: camoscio, cristal

D4: Leder: nabuk, utah

D6: Kundenleder, Kundenstoff

SX

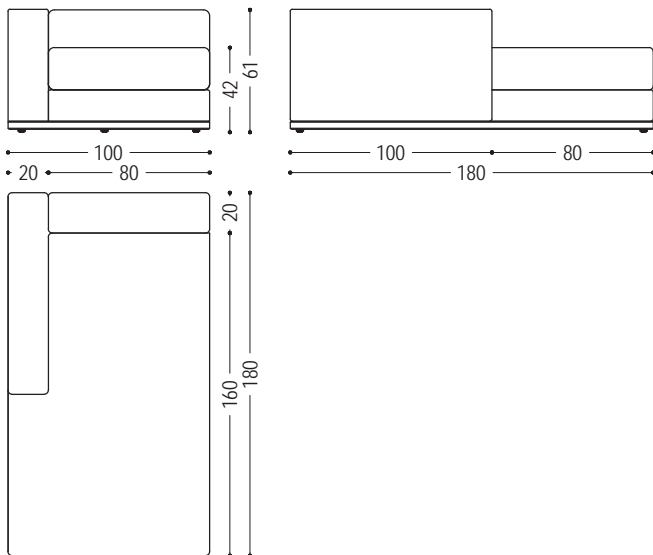

DX

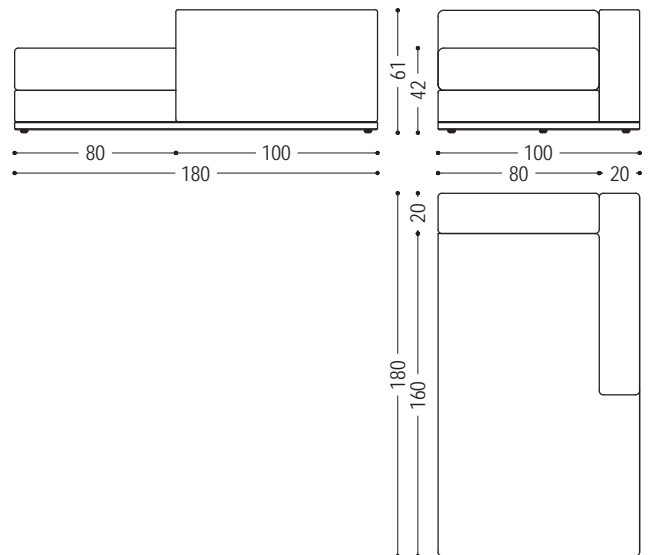

HERITAGE POUF 80X100

ART.NR.	MASS	D1	D2	D3	D4	D6
HR 80-100 MQ	L.80 x T.100 x H.42	■	■	■	■	■

VERFÜGBARE AUSFÜHRUNGEN:

D1: Stoff: canvas, divina melange 2, hallingdal 65, Samt harald

D2: Stoff: maple

D3: Leder: camoscio, cristal

D4: Leder: nabuk, utah

D6: Kundenleder, Kundenstoff

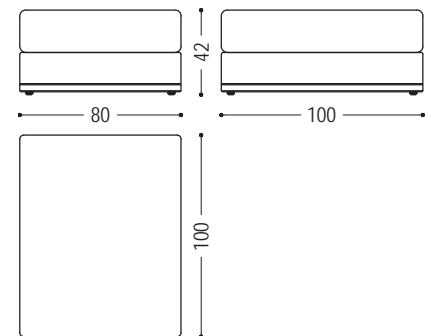

HERITAGE POUF SQUARED 80

ART.NR.	MASS	D1	D2	D3	D4	D6
HR 80 MQ	L.80 x T.80 x H.42	■	■	■	■	■

VERFÜGBARE AUSFÜHRUNGEN:

D1: Stoff: canvas, divina melange 2, hallingdal 65, Samt harald

D2: Stoff: maple

D3: Leder: camoscio, cristal

D4: Leder: nabuk, utah

D6: Kundenleder, Kundenstoff

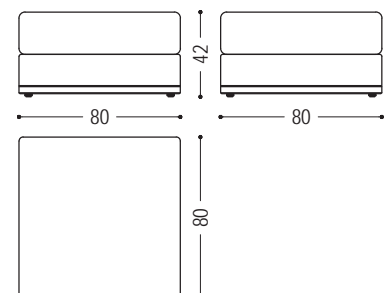

HERITAGE

HERITAGE POUF SQUARED 100

ART.NR.	MASS	D1	D2	D3	D4	D6
HR 100 MQ	L.180 x T.100 x H.42	■	■	■	■	■

VERFÜGBARE AUSFÜHRUNGEN:

D1: Stoff: canvas, divina melange 2, hallingdal 65, Samt harald

D2: Stoff: maple







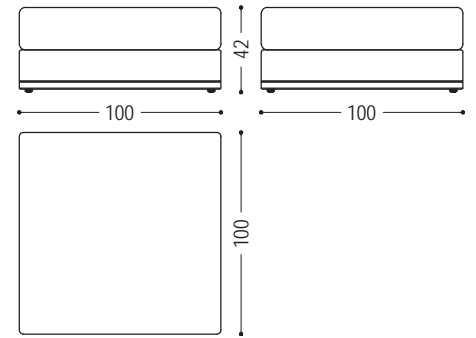



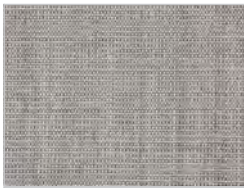
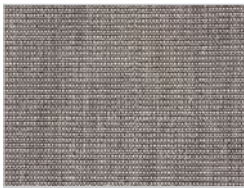
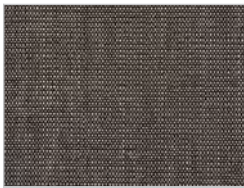





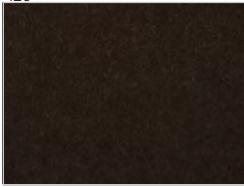



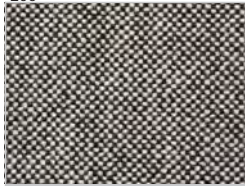









D3: Leder: camoscio, cristal

D4: Leder: nabuk, utah

D6: Kundenleder, Kundenstoff

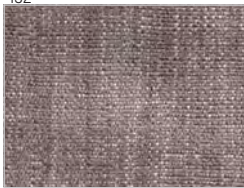

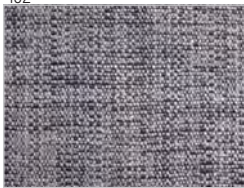
LEDER/STOFFE

D1					
	Stoff: canvas: 114	Stoff: canvas: 124	Stoff: canvas: 134	Stoff: canvas: 154	Stoff: canvas: 174
					
	Stoff: divina melange 2: 120	Stoff: divina melange 2: 170	Stoff: divina melange 2: 180	Stoff: divina melange 2: 220	Stoff: divina melange 2: 260
					
	Stoff: divina melange 2: 280	Stoff: hallingdal 65: 103	Stoff: hallingdal 65: 116	Stoff: hallingdal 65: 130	Stoff: hallingdal 65: 166
					
	Stoff: hallingdal 65: 180	Stoff: Samt harald: 182	Stoff: Samt harald: 242	Stoff: Samt harald: - 283	Stoff: hallingdal 65: 443
					
	Stoff: Samt harald: 512	Stoff: Samt harald: 552	Stoff: Samt harald: 582	Stoff: Samt harald: 792	Stoff: Samt harald: 982
D2					
	Stoff: maple: 112	Stoff: maple: 132	Stoff: maple: 142	Stoff: maple: 162	Stoff: maple: 192
					
	Stoff: maple: 222	Stoff: maple: 232	Stoff: maple: 362	Stoff: maple: 742	Stoff: maple: 792

HERITAGE | VERFÜGBARE AUSFÜHRUNGEN

D3



Leder camoscio:
1



Leder camoscio:
10

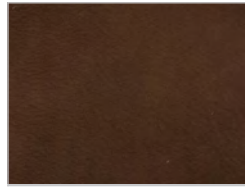

Leder camoscio:
11



Leder camoscio:
26



Leder camoscio:
27

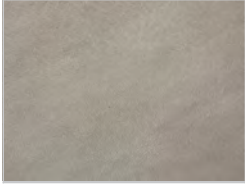

Leder camoscio:
28



Leder camoscio:
31



Leder cristal:
13



Leder cristal:
14



Leder cristal:
17

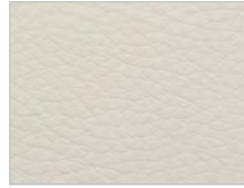

Leder cristal:
18



Leder cristal:
37



Leder cristal:
49



Leder cristal:
51



Leder cristal:
65

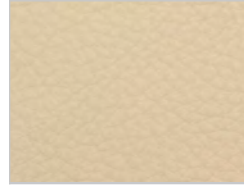

Leder cristal:
70

HERITAGE | VERFÜGBARE AUSFÜHRUNGEN

D4					
	Leder nabuk: 6	Leder nabuk: 12	Leder nabuk: 15	Leder nabuk: 18	Leder nabuk: 23
					
	Leder nabuk: 27	Leder nabuk: 28	Leder nabuk: 30	Leder nabuk: 36	Leder nabuk: 42
					
	Leder utah: 101	Leder utah: 102	Leder utah: 103	Leder utah: 104	Leder utah: 105
					
	Leder utah: 106	Leder utah: 107	Leder utah: 108		